

S4VD-101 487 SERIES 1 1/2" TRIM DOOR FRAME HINGE JAMB @ DRYWALL

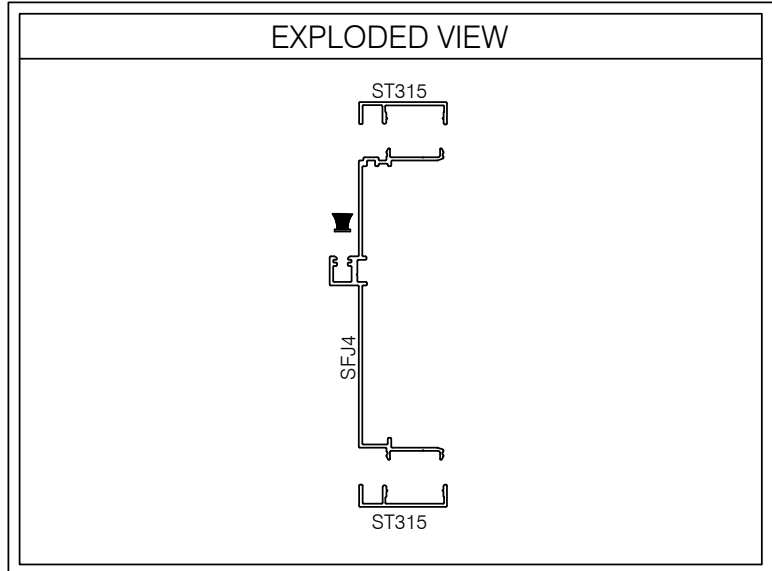
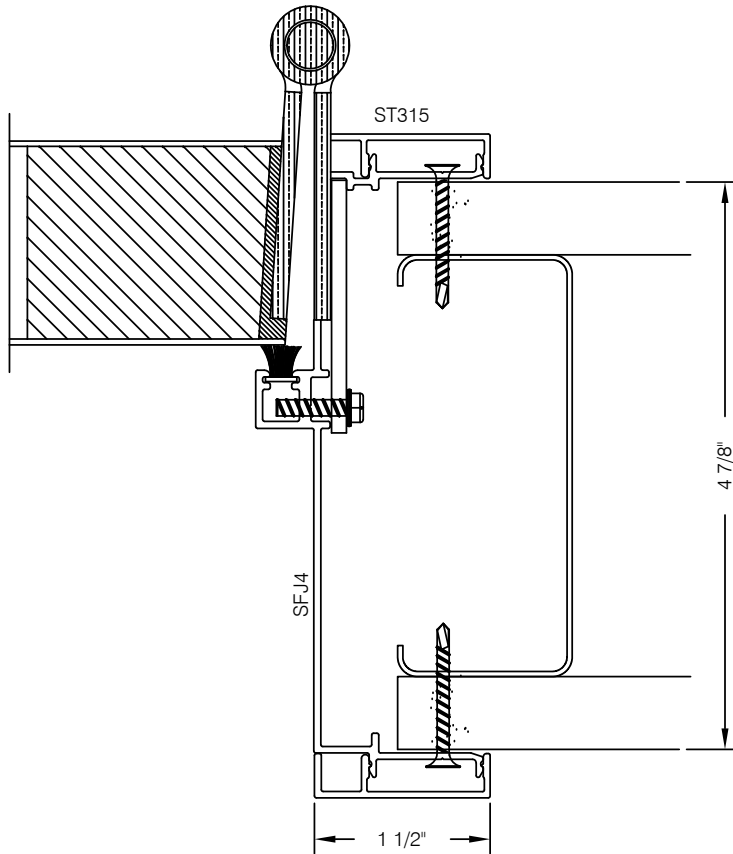

**AlumaPro**  
Interior Frame Systems  
Phone: 713 462-0861  
www.alumapro.com

**IMPRESSIONS**  
Office Front Solutions

DWG NO.	S4VD-101	REV	0
SCALE	Full/Half	SHEET	